

MARTIN Rework Set – Expert 04.6H

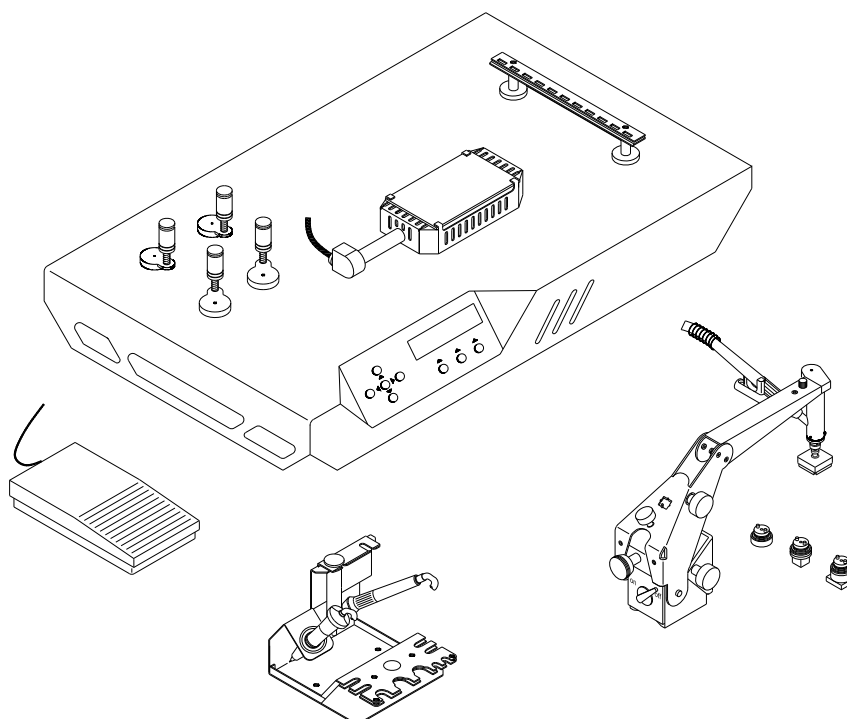

**HA00.4068 Martin Rework Set Expert 04.6H[^]
Chip, QFP, CSP, QFN, for mobile handys...**

1 Piece

Standard Equipment

HA00.5001 SMD solder unit Hot Air 05*
2 nozzles, stand, 4 pcb holder*

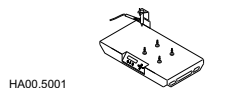

1 Piece

HA00.4010 Dis module for Hot Air 04/05
pen, stand, 2noz0.3, 5n0.58, clean set



1 Piece

HA00.4011 Vac module for Hot Air 04/05
pen, stand, basic eq. (7nozzles,clean,h...)



1 Piece

HA00.4012 Measure module for Hot Air 04/05
2 canals, 2 sensors, capton tape

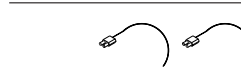

1 Piece

SF33.0003 Smart Fix 02H for IRH element
pcb tableau, pcb rail, pn connector

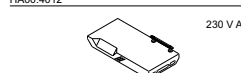

1 Piece

SB04.1002 IRH radiation element - 110 Watt
65*80 mm for HA/DBL 05

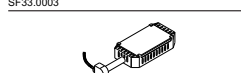

1 Piece

SF42.0001 Positioning arm SHP (xyzd-axis)
double head placer, 3 nozzles+Star Tool



1 Piece

HASX.0005 Solder Star 05: edit progr.+ t-monitor
licence SS, cable, CD, manual



1 Piece

LW01.0015 Soldering tool QFP 15*15mm
for ... PLCC32, ...QFP48s...

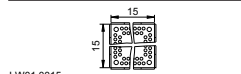



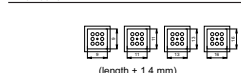

1 Piece

LW40.1102 Soldering nozzle set CSP (LF) (t.w. Expert)
for all types of CSP, 4 pieces (9, 11, 13, 16)

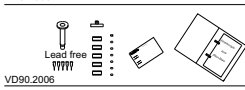

1 Piece

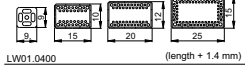
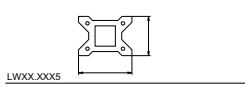
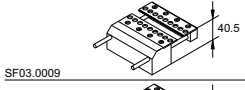
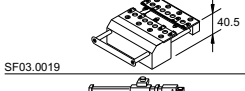
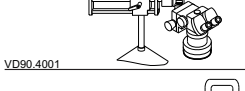
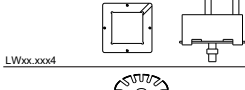
MARTIN Rework Set – Expert 04.6H

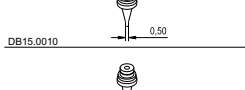
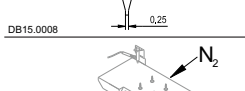
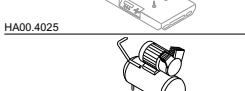
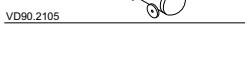
LW10.0002	CSP centering device for Star Tools (rotates)		1 Piece
PD91.0001	Foot switch for CD/HA/DBL ... function start button		1 Piece
VD90.2006	Rework ABC Lead Free 2009* manual with material		1 Piece
Optional Extras			
HASX.0007	Report for SS 05, licence RP		1 Piece
LW01.0400	Soldering tool set SO (lead free)* for all SO...SOL...TSOP, 4 pieces		1 Piece
LWxx.xxx5	Placement Star Tools for all types of CSP/QFN, your choice		1 Piece
SF03.0009	PCB clamping holder 40,5 for mobil phone pcbs on IR/IRD/IRHIRF		1 Piece
SF03.0019	PCB clamping holder 40,5 with fingers for mobil phone pcbs on IR/IRD/IRH/IRF		1 Piece
VD90.4001	Microscope with arm and illumination 5x - 22x (zoom 4.4), 10 - 46mm, 150mm		1 Piece
LWxx.xxx4	Reballing oven and masks for all types of BGA/CSP, your choice		1 Piece
DB96.0002	Magazine for soldering tools revolving, 12 tool positions		1 Piece
DB15.0010	SMD placement nozzle 0.5 mm for 0402 etc.		1 Piece
DB15.0008	SMD placement nozzle 0.25 mm for 0201 etc.		1 Piece
HA00.4025	Nitrogen input for Hot Air 04/05 reduces consumption of N2 for vacuum		1 Piece
VD90.2105	Compressor Super Fox, oil free, noisy 240 l/min, 30 l container		1 Piece