

MARTIN Rework Set – Expert 04.6

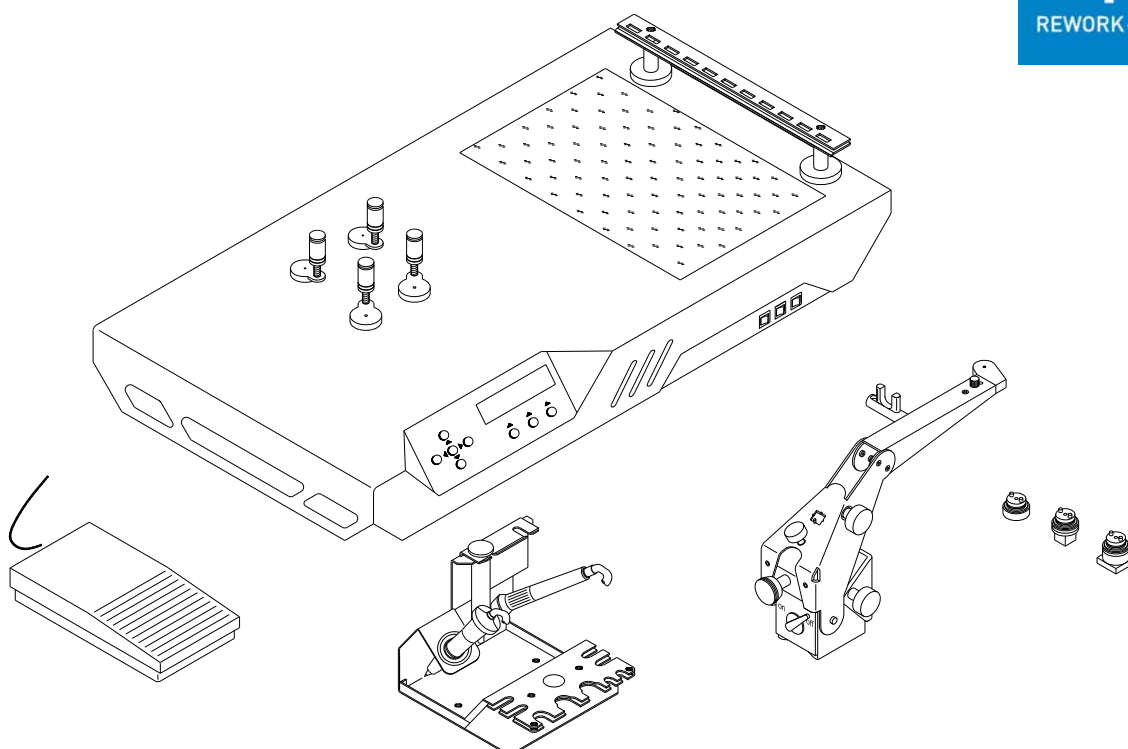

**HA00.4065 Martin Rework Set Expert 04.6[^]
Chip, QFP, BGA, CSP, reballing ...**

1 Piece

Standard Equipment

HA00.5001 SMD solder unit Hot Air 05*
2 nozzles, stand, 4 pcb holder

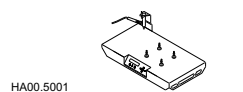

1 Piece

HA00.4010 Dis module for Hot Air 04/05
pen, stand, 2noz0.3, 5n0.58, clean set



1 Piece

HA00.4011 Vac module for Hot Air 04/05
pen, stand, basic eq. (7 nozzles, clean, h...)



1 Piece

HA00.4012 Measure module for Hot Air 04/05
2 canals, 2 sensors, capton tape

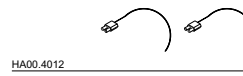

1 Piece

SF33.0002 Smart Fix 02 / IRF 02 - 2000 Watt 230 V AC
IR area 245*185 mm, pcb rail

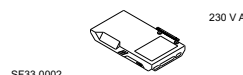

1 Piece

SF42.0001 Positioning arm SHP (xyzd-axis)
Single Head Placer, 3 nozzles Star Tool

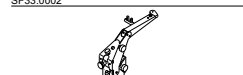

1 Piece

HASX.0005 Solder Star 05: edit progr.+ t-monitor
licence SS, cable, CD, manual



1 Piece

LW01.0101 Soldering tool set QFP (t.w. Expert)
for all PLCC ... QFP, 7 pieces

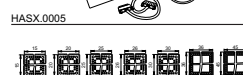

1 Piece

PD91.0001 Foot switch for CD/HA/DBL ...
function start button



1 Piece











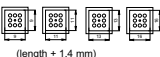
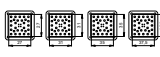
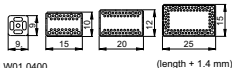

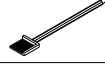
VD90.2006 Rework ABC Lead Free 2009*
manual with material

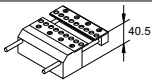
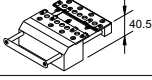

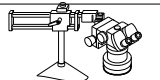
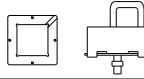
1 Piece

MARTIN Rework Set – Expert 04.6

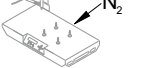
Optional Extras

HASX.0007	Report for SS 05, licence RP	 Report	1 Piece
LW40.1097	Soldering tool set CSP (lead free) for all types of CSP, 4 pieces (9, 11, 13, 16)	 (length + 1.4 mm)	1 Piece
LW40.1100	Soldering tool set BGA^ 4 pieces (27, 31, 35, 37,5)		1 Piece
LW01.0400	Soldering tool set SO (lead free)* for all SO...SOL...TSOP, 4 pieces	 (length + 1.4 mm)	1 Piece
LW39.1999	Star Tool set BGA for all (98%) types of BGA placement tool for ASP/SHP, 7 pieces		1 Piece
LWxx.xxx5	Placement Star Tools for all types of CSP/QFN, your choice		1 Piece
LW10.0002	CSP centering device for Star Tools (rotates)		1 Piece
SF01.0100	PCB clip for large pcbs onto IRF handrest		1 Piece
SF03.0009	PCB clamping holder 40.5 for mobil phone pcbs an IR/IRD/IRH/IRF	 40.5	1 Piece
SF03.0019	PCB clamping holder 40.5 with fingers for mobil phone pcbs on IR/IRD/IRH/IRF	 40.5	1 Piece
SF30.0004	PCB support 40.5 for IRF02/06/07, pcb=1.5mm	 1.5 38.0	4 Pieces
SF30.0005	PCB support 40.5 for IRF02/06/07, pcb=3mm	 3 38.0	4 Pieces
VD90.4001	Microscope with arm and illumination 5x - 22x (zoom 4.4), 10 - 46mm, 150mm		1 Piece
LWxx.xxx4	Reballing oven and masks for all types of BGA/CSP, your choice		1 Piece
DB96.0002	Magazine for soldering tools revolving, 12 tool positions		1 Piece
DB15.0010	SMD placement nozzle 0.5 mm for 0402 etc.	 0.50	1 Piece
DB15.0008	SMD placement nozzle 0.25 mm for 0201 etc.	 0.25	1 Piece
HA00.4025	Nitrogen input for Hot Air 04/05 reduces consumption of N2 for vacuum	 N ₂	1 Piece
VD90.2105	Compressor Super Fox, oil free, noisy 240 l/min, 30 l container		1 Piece