

MARTIN Rework Set – Expert 09.6

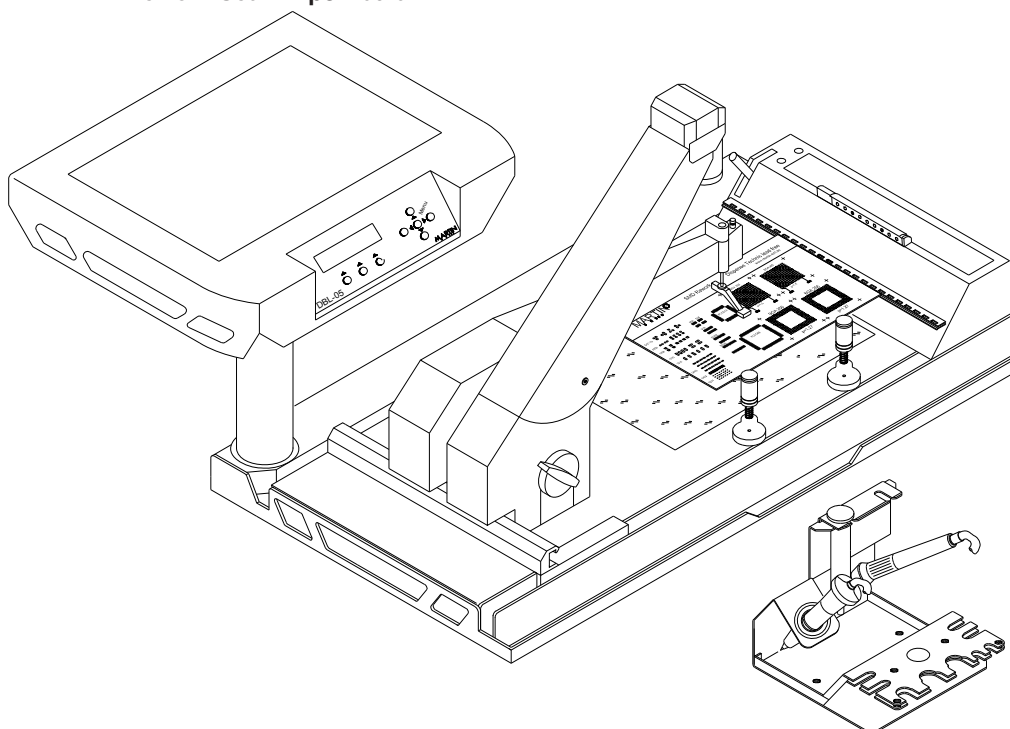

DB00.2964 Martin rework set Expert 09.6^
Chip,QFP,BGA,CSP, QFN, auto placement

1 piece

Standard Equipment

- DB00.0006 SMD compact unit DBL 05*
with basic equipment
- EB16.0003 Second soldering pen to clean pads
with 7 pin plug, d=20mm
- SF66.0010 Auto Vision Placer 04 for DBL 05
contr., arm, 4 nozzles, camera, 2 lenses
- SF00.0030 Smart Fix 06 / IRF 06 - 3000 Watt*
IR area 245 x 275 mm, 4m, 8s, slide rail
- DVSX.0006 Easy Solder 05 PC control WIN PC
license SS+ES, cable, CD, manual
- LW01.0101 Soldering tool set QFP (t.w. Expert)
for all PLCC ... QFP, 7 pieces
- PD91.0001 Foot switch for CD/HA/DBL ...
function start button
- VD90.2006 Rework ABC Lead Free 2009*
manual with material



DB00.0006

1 piece



EB16.0003

1 piece



SF66.0010

1 piece

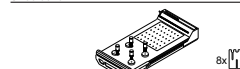

SF00.0030

1 piece



DVSX.0006

1 piece

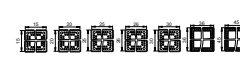

LW01.0101

1 piece



PD91.0001

1 piece

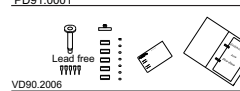

VD90.2006

1 piece

MARTIN Rework Set – Expert 09.6

Optional Extras

SF66.0004	Micro SMD nozzles and lens for AVP4 license MS, 3 n., 3 solder n., lens FC
DVSX.0007	Report with PCB identification for ES 05, license RP
SF66.0110	Lens Maxi BGA for AVP4, f=16mm, 70x95mm
LW40.1097	Soldering tool set CSP (lead free)* for all types, 4 pieces (9, 11, 13, 16)
LW40.1099	Soldering nozzle set BGA 7^ for all (98%) types of BGA, 7 pieces
LW01.0400	Soldering tool set SO (lead free)* for all SO...SOL...TSOP, 4 pieces
SF36.1001	PCB flex support 40.5 for IRF 04/05/06/07, 10 point pillow
SF03.0009	PCB clamp 40.5 for mobil phone pcb and BGAs
SF03.0019	PCB clamping holder 40.5 with fingers for mobile phone pcs on IR/IRD/IRH/IRF
LWxx.xxx4	Reballing oven and masks for all types of BGA/CSP, your choice
DB96.0002	Magazine for soldering tools revolving, 12 tool positions
SF71.0001	Side Camera for ES 05, camera, stand, cable, DVD
DB00.0025	Nitrogen input for DBL 04 / 05 (2.p.r.) reduces consumption of N2 for vacuum
SF01.0100	PCB clip for large pcs onto IRF handrest
SF03.0014	PCB magnet holder Easy Lock 40.5 (snap) for IRF radiation element
VD90.2105	Compressor Super Fox, oil free, noisy 240 l/min, 30 l container
VD90.1002	Control unit WINXP prof. eng 3.3GHz, 1024MB, DVD, 19" TFT 1280x1024



SF66.0004

1 piece



DVSX.0007

1 piece



SF66.0110

1 piece

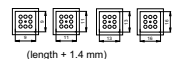

LW40.1097

1 piece

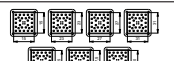

LW40.1099

1 piece

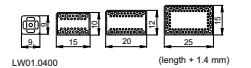

LW01.0400

1 piece



SF36.1001

1 piece

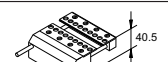

SF03.0009

1 piece

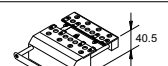

SF03.0019

1 piece

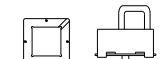

LWxx.xxx4

1 piece



DB96.0002

1 piece



SF71.0001

1 piece



DB00.0025

1 piece



SF01.0100

1 piece

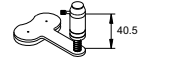

SF03.0014

1 piece



VD90.2105

1 piece



VD90.1002

1 piece

For very small pcb

SB04.1001	IRH booster radiation element - 110 Watt 65*80 mm for HA/DBL 05, with holder
SF00.0107	Switch box IRH <=> IRF 04/05/06/07 with pneumatic connector, for DBL 05



SB04.1001

1 piece



SF00.0107

1 piece